

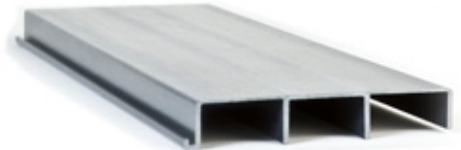

COMPOSITE DECKING

PROForms®

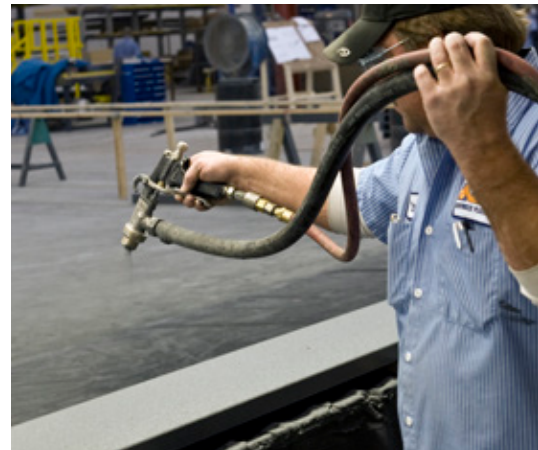

APPLICATIONS

- Boat docks
- Bridge decks and walkways
- Filter media supports
- Hatch covers
- Paneling and roofing
- Pools and recreation areas
- Replacement for covered closed grating
- Tank covers for odor control

BENEFITS

- Strong yet lightweight
- Won't rot, rust, warp or bow
- Easy, flexible installation
- Eliminates tripping hazards
- Versatile and cost-effective
- Low-maintenance
- Non-conductive

OPTIONS

- Vented surface
- Anti-skid surface (when installed as a walking surface)

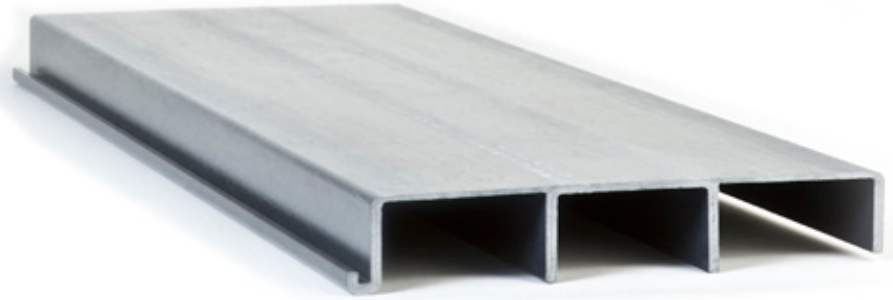

The lap joint design of our 24" decking allows flexible installation in situations where structural inaccuracies exist.



Our FRP decking is manufactured with the pultrusion process using polymer resins and fiberglass reinforcements.

ELIMINATE CORROSION, ROT AND MORE WITH FRP DECKING

Need a long-term solution for walkways, deck systems, roofing or tank covers? Bedford's fiberglass-reinforced polymer (FRP) deckboard is strong, corrosion-resistant and easy to install with standard tools. It's also available with a non-slip coating for added safety. In short, FRP deckboard is the ideal alternative to replace wood or other less versatile surfaces such as steel and aluminum in cooling towers, recreation docks and walkways – anywhere the life span of the decking really counts.

Whether you need FRP decking or a complete FRP system with handrails, stairs and platforms, Bedford has the solution to match. In addition to our products, we offer in-house design, engineering and fabrication capabilities to meet your project needs.



PROForms® Deckboard Load and Deflection Data

CONCENTRATED LOAD

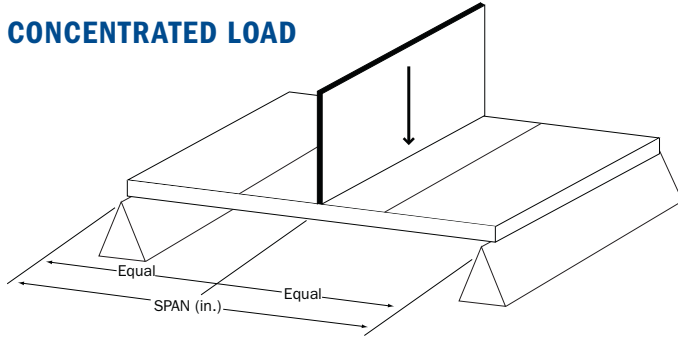

UNIFORM LOAD

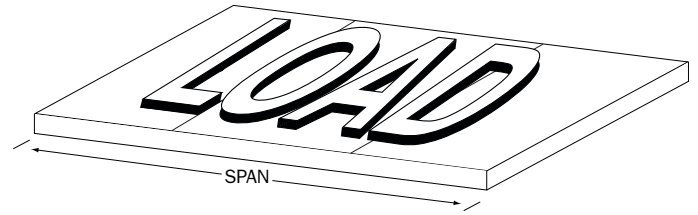

24" x 1.125" Deckboard

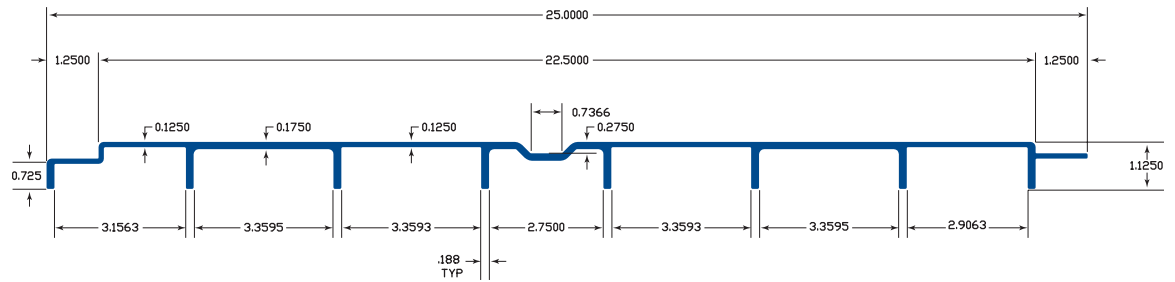

Span (inches)	CONCENTRATED LOAD in lbs/width of the panel							
	20	40	60	80	100	150	200	300
24	0.006	0.012	0.017	0.023	0.029	0.044	0.058	0.087
30	0.009	0.018	0.026	0.035	0.044	0.066	0.088	0.132
36	0.015	0.029	0.044	0.059	0.074	0.110	0.147	0.221
42	0.023	0.047	0.070	0.094	0.117	0.175	0.234	0.351
48	0.035	0.070	0.105	0.140	0.175	0.262	0.349	

Span (inches)	UNIFORM LOAD in Lb/ft ²							
	20	40	60	80	100	150	200	300
24	0.015	0.029	0.044	0.058	0.073	0.109	0.145	0.218
30	0.028	0.055	0.083	0.110	0.138	0.207	0.276	
36	0.055	0.110	0.166	0.221	0.276			
42	0.102	0.205	0.307					
48	0.175	0.349						

Wt. lb/ft	C/S Area, in ²	I, in ⁴	S, in ³
4.10	5.11	0.44	0.52

24" x 1.5" Deckboard

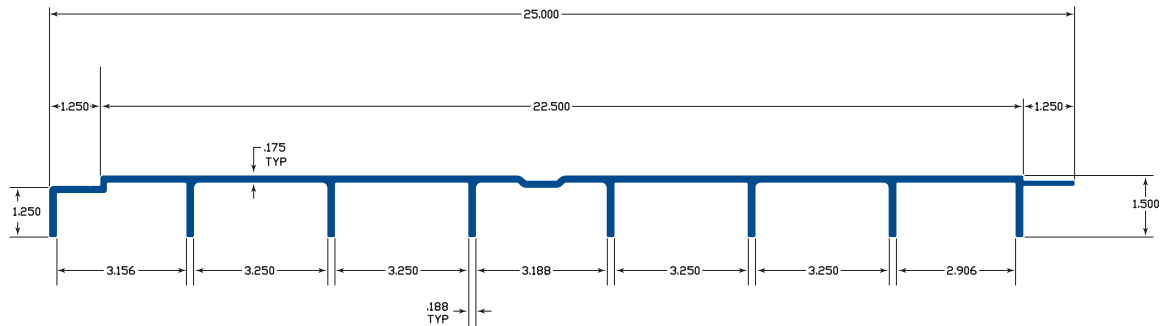

Span (inches)	CONCENTRATED LOAD in lbs/width of the panel							
	20	40	60	80	100	150	200	300
24	0.002	0.004	0.006	0.008	0.010	0.014	0.019	0.029
30	0.003	0.007	0.010	0.014	0.017	0.026	0.034	0.051
36	0.005	0.011	0.016	0.021	0.027	0.040	0.053	0.080
42	0.008	0.016	0.025	0.033	0.041	0.062	0.082	0.123
48	0.012	0.024	0.036	0.048	0.060	0.089	0.119	0.179

Span (inches)	UNIFORM LOAD in Lb/ft ²							
	20	40	60	80	100	150	200	300
24	0.005	0.010	0.014	0.019	0.024	0.036	0.048	0.072
30	0.011	0.021	0.032	0.043	0.053	0.080	0.107	0.160
36	0.020	0.040	0.060	0.080	0.100	0.150	0.200	0.299
42	0.036	0.072	0.108	0.144	0.180	0.269	0.359	
48	0.060	0.119	0.179	0.238	0.298			

Wt. lb/ft	C/S Area, in ²	I, in ⁴	S, in ³
5.72	6.31	1.03	0.89



PROForms® Deckboard Load and Deflection Data

12" x 2.120" Deckboard

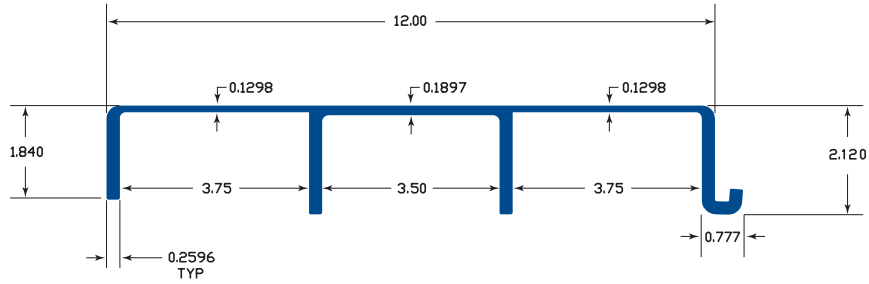

Span (inches)	CONCENTRATED LOAD in lbs/width of the panel							
	50	100	150	200	300	500	1000	1500
30	0.007	0.014	0.020	0.027	0.041	0.068	0.135	0.203
36	0.010	0.021	0.031	0.041	0.062	0.104	0.207	0.311
42	0.016	0.031	0.047	0.063	0.094	0.157	0.313	
48	0.022	0.045	0.067	0.089	0.134	0.223		
60	0.044	0.087	0.131	0.174	0.261			

Span (inches)	UNIFORM LOAD in Lb/ft ²							
	50	100	150	200	300	500	1000	1500
30	0.011	0.021	0.032	0.042	0.063	0.106	0.212	0.317
36	0.019	0.039	0.058	0.078	0.117	0.194	0.389	
42	0.034	0.069	0.103	0.137	0.206	0.343		
48	0.056	0.111	0.167	0.223	0.334			
60	0.136	0.272						

Wt. lb/ft	C/S Area, in ²	I, in ⁴	S, in ³
2.90	3.94	1.91	1.31

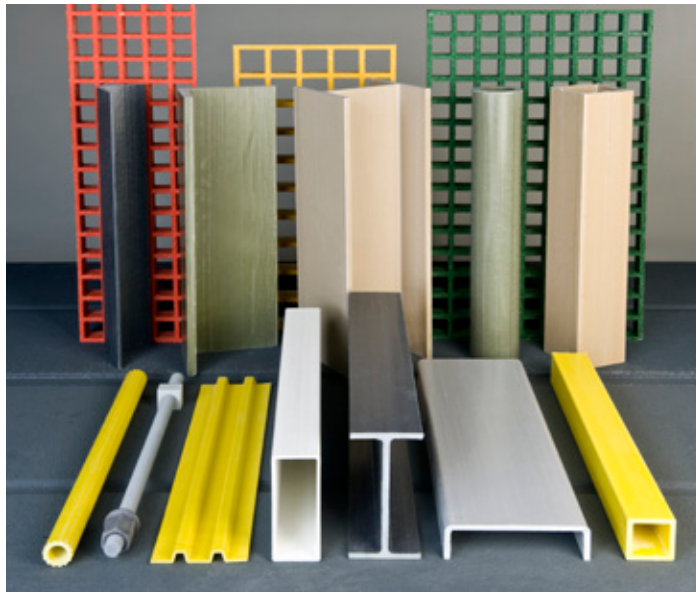

COMPLETE FRP SOLUTIONS

Explore our full range of PROForms® standard and custom profiles, PROGrid® molded grating and PROGrate® pultruded grating at bedfordreinforced.com. We can also produce complete fabricated systems with stairs, handrails, platforms and/or ladders and cages to your specifications.

Beyond these products, we offer engineering, design, drafting, fabrication, secondary coating and painting, and in-house testing services to help you maximize the benefits of FRP. Call our FRP professionals for assistance or request a quote today!



Request a quote at bedfordreinforced.com or call **800-377-3280**.

BEDFORD REINFORCED PLASTICS | ONE CORPORATE DRIVE, SUITE 106, BEDFORD, PA 15522
 LOCATIONS NATIONWIDE: BEDFORD, PA · FRESNO, CA · HOUSTON, TX · TAVARES, FL · SALT LAKE CITY, UT

The photographs and/or drawings in this literature are for illustrative purposes only. While every reasonable effort has been made to ensure the accuracy of this data, we are not responsible for any errors or omissions contained on these pages. Please verify any information in question with a Bedford sales representative. We reserve the right to make changes in specifications without notice and without incurring obligation. © 2014 Bedford Reinforced Plastics. All rights reserved. 04/14